

Innovative & Dependable!

Geoprobe® Direct Image® Machines & Tools  
Making Direct Sensing Easier



Geoprobe Systems®

1-800-436-7762 | Fax: 785-825-6983  
www.geoprobe-di.com

## Low Level MIP

### Standard Operating Procedure

#### 1.0 Description

The low level (LL) MIP method works due to special management and control of the trunkline system carrier flows. In standard MIP operation, the carrier gas continually sweeps across the membrane transporting contaminants to the detectors at the surface. In the LL MIP method, the trunkline sweep flow is temporarily stopped when the MIP probe is brought to rest at a discrete depth in the soil. Stopping the sweep gas flow allows the contaminant concentration to build behind the membrane. This results in a larger and narrower contaminant response peak at the detectors for a given chemical concentration (Figure 1). A switching valve located inside the MP9000 creates separate gas flow paths for the MIP trunkline and detectors, which allows the trunkline flow to be stopped and restarted with minimal impact of detector baselines or stability. When the trunkline flow is restarted the contaminant mass (peak) is quickly swept to the surface with a trunkline flow rate of approximately 60ml/min. and is routed to the detectors via a sample valve located in the MP9000. Figure 1 shows the difference of standard and LL MIP response levels.

In the LL MIP mode the trunkline carrier gas is vented out most of the time with clean carrier gas being sent to the detectors, only at the end of the TL transport mode (Figure 10) is the trunkline carrier gas redirected to the detectors by the sample valve. The time when the redirection of the trunkline carrier gas occurs is determined by the MIP operator.

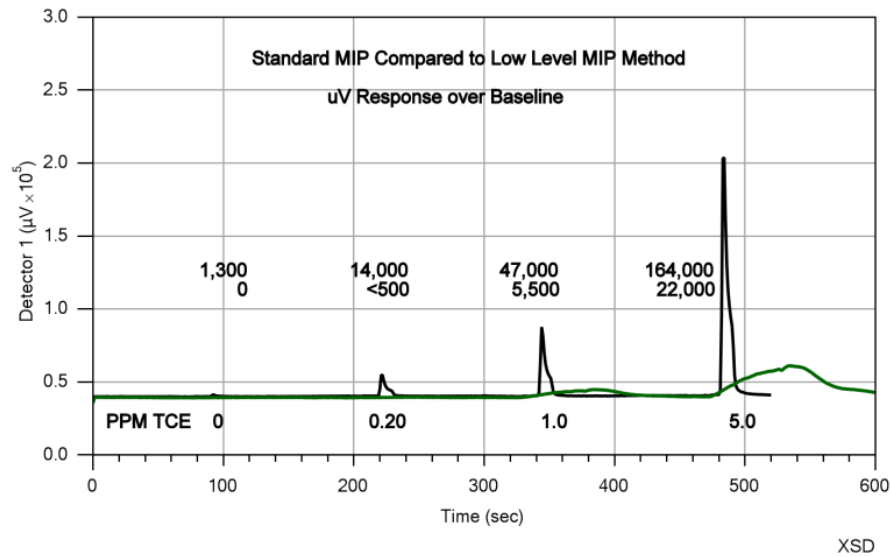

Figure 1: Standard vs. Low level MIP Response

## 2.0 Setup

Setup of the low level system is all done with management of the gas line connections which are located on the back of the instrument (Figure 2). The back of the instrument also has connections for power and USB communication to the operator's laptop. The first time a LL controller is connected to a laptop by the USB cable it must be the only connection to the laptop for the first 30seconds (do not have the FI6000 also connected) to allow the USB drivers to properly load. After the first computer configuration all connections can be in place on startup.

### 2.1 Trunkline Connections:

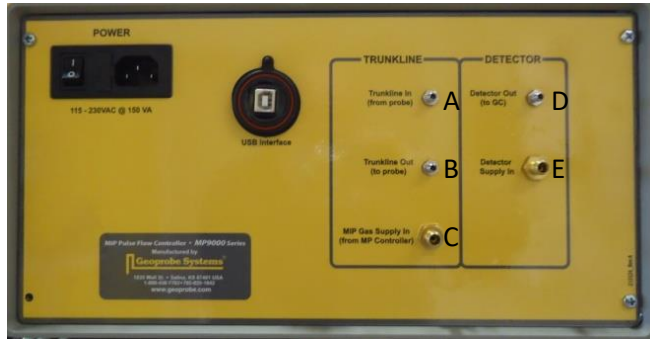

Figure 2: MP9000 Controller – Back of instrument

- Trunkline In: A 1/16" Swagelok bulkhead (A) that connects to the trunkline return gas line which is either Peek tubing or stainless steel.
- Trunkline Out: A 1/16" Swagelok bulkhead (B) that connects to the supply gas line of the trunkline which is typically Teflon or the uncovered SS line in the heated trunkline.
- MIP Supply Gas In: An 1/8" Swagelok bulkhead (C) connected to the MIP controller regulated output.

### 2.2 Detector Connections:

- Detector In: An 1/8" Swagelok bulkhead (E) that is connected to the Nitrogen gas tank supply. The Pressure gauge on the front panel should be set to 5PSI (Fig. 3) and the flow rate should be set to 40ml/min. This provides a constant gas flow to the detectors resulting in stable baseline on the detectors during all modes except when the trunkline gas is directed to the detectors.
- Detector Out: A 1/16" Swagelok bulkhead (D) that connects the LL MIP controller to the gas chromatographs inlet to the detectors, typically leading into the Nafion Dryer.

### 2.3 Front Panel Switches and Buttons:

- Auto/Manual Switch: This switch is located on the line between auto and manual blocks on the front of the MP9000 controller (Figure 3). To operate LL MIP in automated mode this switch must be to the left with the auto light lit. When the controller is powered up and this is in auto mode, the operator can start the LL Mode by opening the DI Acquisition software and before starting a log, open the sensors tab on the top of the page and click "Low level mode."
- Sample Valve Switch will manually change the 4 port valve between its 2 positions. In Vent mode the trunkline carrier gas is being vented and the detector gas is sweeping back to the detectors. In Detector mode the trunkline gas is sent directly to the detectors. This switch is only active during manual operation.
- Trunkline Flow Switch manually turns the trunkline carrier gas flow off and on. This switch is only active during manual operation. Both the sample valve switch and the trunkline flow switch only operate in manual mode. No connection is made with these switches during automated operation.



Figure 3: MP9000 Controller – Front of instrument

### 3.0 Software Timing

These times all refer to the trunkline carrier gas and the position of the contaminant peak as well as the times when the valve inside the LLMIP controller is switched.

**No Flow Time:** The no-flow time (or collection mode in Fig. 6) is the amount of time you choose to wait at each sampling interval with the trunkline flow blocked off collecting the sample. During this time, the trunkline flow is blocked as contaminants diffuse through the membrane and build into a large contaminant mass behind the membrane. During this time the detectors see clean carrier gas from the GC (Fig. 12) which provides stability to the detector baselines. The no flow time is typically set between 30-45 seconds. When the rig operator reaches the interval to sample and the ROP goes to zero for a set amount of time (Fig. 4) the software will automatically start the LL cycle sequence. If the desired sampling interval is missed either by stopping short or too long for the automatic cycling to begin, the operator can manually start the cycle by either pressing the start button on the front of the MP9000 or the start button in the software on the status menu. This can also be accomplished in manual mode by turning the TL flow switch off and back on after the desired no flow time has expired.

**Vent Time:** This is the amount of time immediately after restarting of the trunkline flow that the trunkline exhaust remains vented and is not sent to the detectors. The vent time is also referred to as the trunkline transport mode in the status screen of Figure 6 and a drawing of this is seen in Figure 13. We want to maintain some time here while the trunkline flow is recovering and transporting the sample to the surface. When you are initially trying to determine when the response peak will occur it makes sense to have a low vent time perhaps 10seconds and allow the trunkline return to freely flow to the detectors. Once the peak response time is determined it is recommended to increase the vent time to within 15 seconds of the expected response. This will allow the operator to see the benefits of having a longer vent time which include being able to accurately monitor the recovery of the carrier gas return flow rate which is measured in the vent pathway as well as the MIP pressure. When the trunkline return is switched to being injected to the detectors the return flow rate will be reading the detector gas flow.

**Inject to Detector Time:** This is the amount of time that the trunkline flow is transported directly to the detectors. This is referred to as both TL Transport and Inject to Det. in the LL status mode of Fig 6 with a drawing of this seen in Figure 14. It is recommended to have approximately a 20second Inject to detector time. If the switch is made back to vent (the cycle goes to standby) prior to the arrival of the contaminant response then no peak will be seen. This can be adjusted by increasing the vent time which will be discussed further in section 9.0. When first determining your LL timing it is wise to have an extra long Inject time such as 90 seconds as shown in Table 1. This will ensure that the contaminant peak will make it to the detector with plenty of time of time to spare. Then the extra time can be removed from the overall timing (Vent + Inject) which is shown in Tables 1 & 2 and Figures 7 & 8.

#### Manual Operation:

To manually operate the LL MIP method the MIP operator will be at the control panel of the MP9000 with a stopwatch in hand. The MP9000 will be set to manual mode with the trunkline flow on and the sample valve in the vent position. When the rig operator reaches the target sample depth the trunkline flow switch will be switched to the "off" position. Using the times listed in Figure 4, the trunkline flow switch is turned "on" after 45 seconds and the stopwatch started. The sample valve switch is changed to the "detector" position after 40 seconds and back to vent after another 20 seconds have passed since the restarting of the trunkline flow. This process will be repeated at each sampling interval for the depth of the log.

## 4.0 LL MIP DI Acquisition Software

### 4.1 LL MIP Display Setup Screen

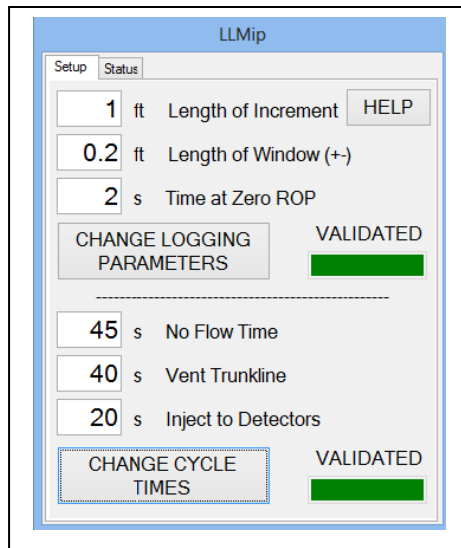

Figure 4: LL MIP Setup Screen

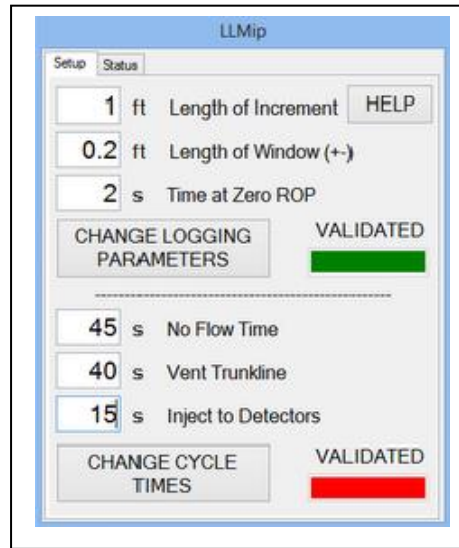

Figure 5: LL MIP Setup Screen

The top parameters of the LL MIP setup screen are for the frequency of the sampling event. In this case (Figure 4) the system is running the LL cycle every 1'. When the probe is advanced to  $1' \pm 0.2'$  and the probe advancement stops for 2 seconds in that depth window the LL cycle will automatically run.

The lower section of the setup screen displays the LL MIP timing events as described before. The “no flow time” is the sample collection at the probe membrane with the trunkline carrier flow turned off (45sec). The “Vent Trunkline” time is the amount of time after the restarting of the trunkline flow that the trunkline return line is vented away and not sent to the detectors (40 seconds). At the end of the “Vent Trunkline” time, the valve switches and redirects the trunkline return gas to the detectors. The “Inject to Detectors” time is the amount of time that the trunkline flow will be directed to the detectors (20 seconds).

Any of these values can be changed so long as the software is not in the middle of a cycle. To change the values, simply type over the entered values, this will create a red code on the validation (Figure 5), when the changes are complete click on the “change cycle times” button and the validated sign will turn from red to green.

### 4.2 LL MIP Display Status Screen

The status screen (Figure 6) is where you can see where you are in the LL cycle. These status descriptions all refer to the position of the contaminant slug.

- Standby - ready to start next cycle
- Collection - TL flow off – collection at the membrane
- TL Transport - TL flow turned on sample moving up the trunkline.
- TL Transport/Inject to Detector – Both will light up as the valve is switched directing the contaminant slug to the detectors.

When the data light blinks orange the system is in communication with the control box. The “Next Window” indicates the depth range for the next sample collection. GC detector gas flows and the trunkline return flows can be observed here.

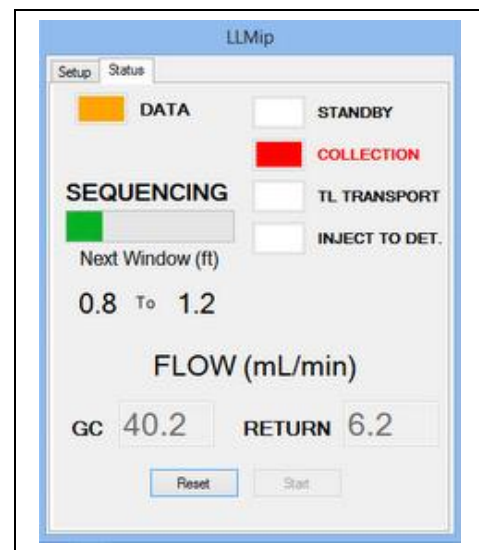

Figure 6: LLMIP status screen

## 5.0 Setting Flows

Typical flow rates for the trunkline when operating the LL MIP method would be 60ml/min when using a 150' TL. Higher TL flows rates will reduce the amount of time it takes to transport the sample to the detectors. The GC/detector gas flow should be set to 40ml/min. This is the carrier gas stream that is continually flowing across the detectors whether or not the TL gas is flowing.

The greater the difference in the flow rates used in the trunkline and GC will result in increased amounts of noise seen by the detectors as a result of differences in baseline levels. For a more stable baseline these flows should be closer together.

## 6.0 Setting your LL Cycle Times

No Flow Time	45 sec
Vent Trunkline	10 sec
Inject to Detectors	90 sec

Table 1: Initial LL Times

The response in Figure 7 is using the LL cycle times listed in Table 1 to ensure the peak is found. Next the operator will refine the times to isolate the peak. In this example the operator used a 90 second TL inject time which can be seen between 55-145 seconds when the valve was switching. The operator will want to increase the vent time by at least 20 seconds. The “inject to detector” time needs to be lowered by about 45 seconds as well as the 20 seconds added to the vent time. So a total of 65 seconds will be subtracted from the 90second inject time. See adjusted times in Table 2.

No Flow Time	45 sec
Vent Trunkline	30 sec
Inject to Detectors	25 sec

Table 2: Adjusted LL Times

The response in Figure 8 is using the adjusted LL cycle times listed in Table 2. This has a much more refined TL inject to detector window around when the peak actually comes through the system. If desired, the operator can refine this more. It is recommended that the operator sets the “inject to detector” time to 15-25 seconds in length which will leave plenty of room for system fluctuations. The operator won't want to wait more than 10seconds after the peak response for the valve to switch back to standby since added time will just be time wasted waiting for the system to be ready to sample the next interval.

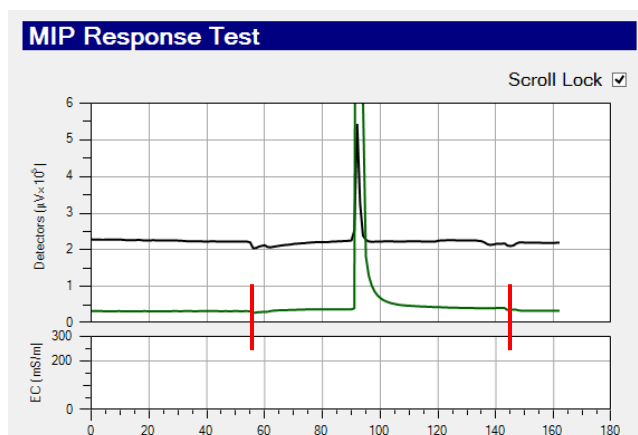

Figure 7: Initial LL-MIP Response

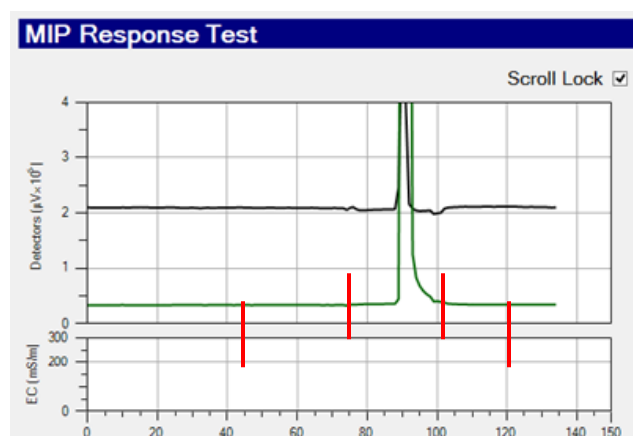

Figure 8: Response Test with revised times

## 7.0 Operator Hold Time

The machine operator will need to remain at a given sampling position for the sample collection time, vent and all but 10seconds of the Inject times. In the case of the times used in Table 2, the operator reaches the sample collection point and will hold for 45 seconds no flow time + 30 seconds vent trunkline + 25 seconds of the inject time for a total of 100 seconds. The operator can push the tool in this case every 90 seconds and he needs to take his time advancing to the next interval ~15 seconds per foot. This will ensure that the LL cycle will be finished from the previous sampling interval and back in standby mode when the operator reaches the next sampling interval. If the operator reaches the next sampling interval before the LL cycle is ready the MIP probe will be heating and transporting contaminants away from the probe without operating a no-flow collection state. These removed contaminants will be vented away and not seen at the detectors. This inadvertent removal of contaminants could result in a recorded clean zone where contaminant response would have been seen.

## 8.0 Trip Time

The trip time (TT) entered into the software will be the total of the vent and inject time which will place the detector response back at the sampled interval it came from. In this case that will be 55seconds.

### LL Cycle Times

- No Flow time – 45s
- Vent time – 30s
- Inject time – 25s

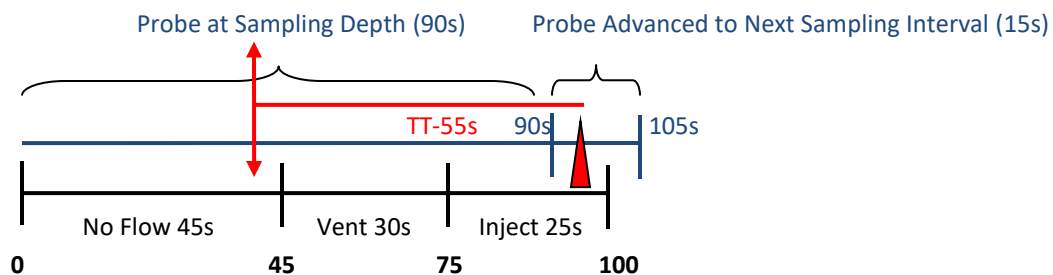

## 9.0 Peak Response Identification and Vent Timing Modification:

Make sure that the operator entered LL times (Fig. 4) provide adequate room for fluctuation in TL flow when the valve switches off of injecting trunkline to the detectors. It is recommended that the operator use a 20-25second inject time which will allow for adequate room for system gas fluctuations. The peak shapes in Figure 9 show proper timing of the valve changing with room before and after the peak. If adjustments are needed they can be done increasing or decreasing the vent time in the LL cycle times.

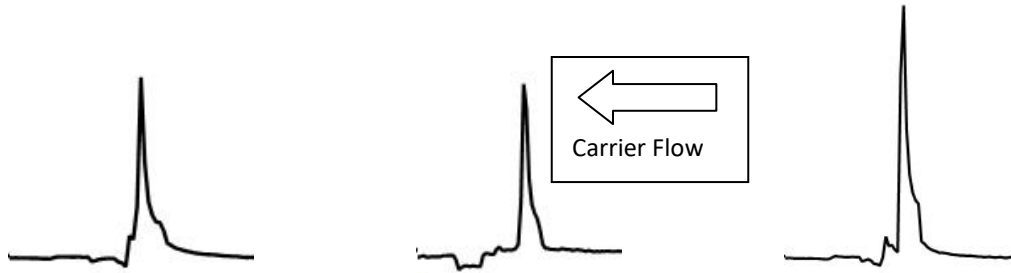

Figure 9: Example peaks with a properly set vent and Injection time

The detectors will determine if an initial dip in the detector baseline is seen before the peak occurs as seen in Figure 9 but there should be a bit of a shoulder of the peak before the response drops back to baseline.

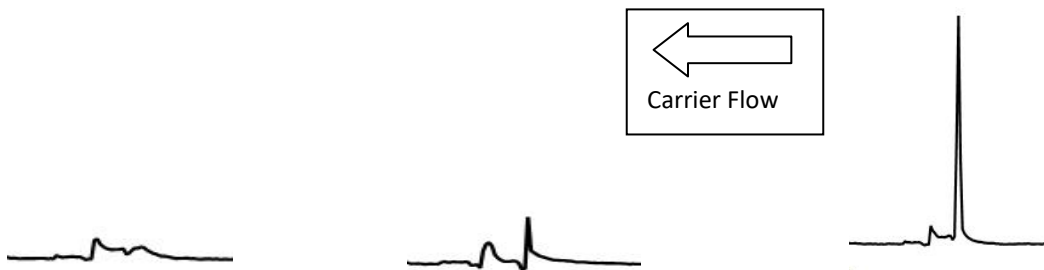

Figure 10: Example peaks where the Vent time is set too short – the peak is being cut-off by the valve switching.

In Figure 10 the peak has not yet reached the valve or has barely past when it switched cutting off the peak. This is seen by a bit of baseline dip and either no peak or a sharp peak with no evidence of a peak tail at all. Adjust this by increasing the vent time by 10-15 seconds.

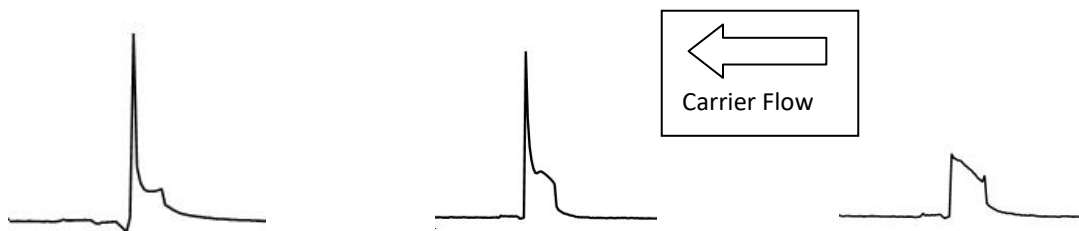

Figure 11: Example peaks where the Vent time is set too long – the front of the peak is being vented.

The peaks in Figure 11 have too long of a vent time resulting in the venting of the front of these contaminant peaks. To ensure that we see the full peak, decrease the “trunkline vent” time by 10-15 seconds and make sure that the “inject to detector” time has about 25 seconds. This will shift the trunkline carrier gas that is directed to the detectors and provide a more accurate timing of where the compounds will be in the carrier gas.

## 10.0 Gas Flow Paths and 4 Port Valve Configurations

Valve configuration 1 is used during standby, collection and the first part of the transport mode. In Figure 12 the system is in the collection mode when the sample is being collected at the membrane. The trunkline carrier gas is plugged off at the 3-way shutoff valve at the surface allowing no flow to go through the trunkline. The detectors continue to receive a supply clean carrier gas passing through valve positions 3-2 and on to the detectors.

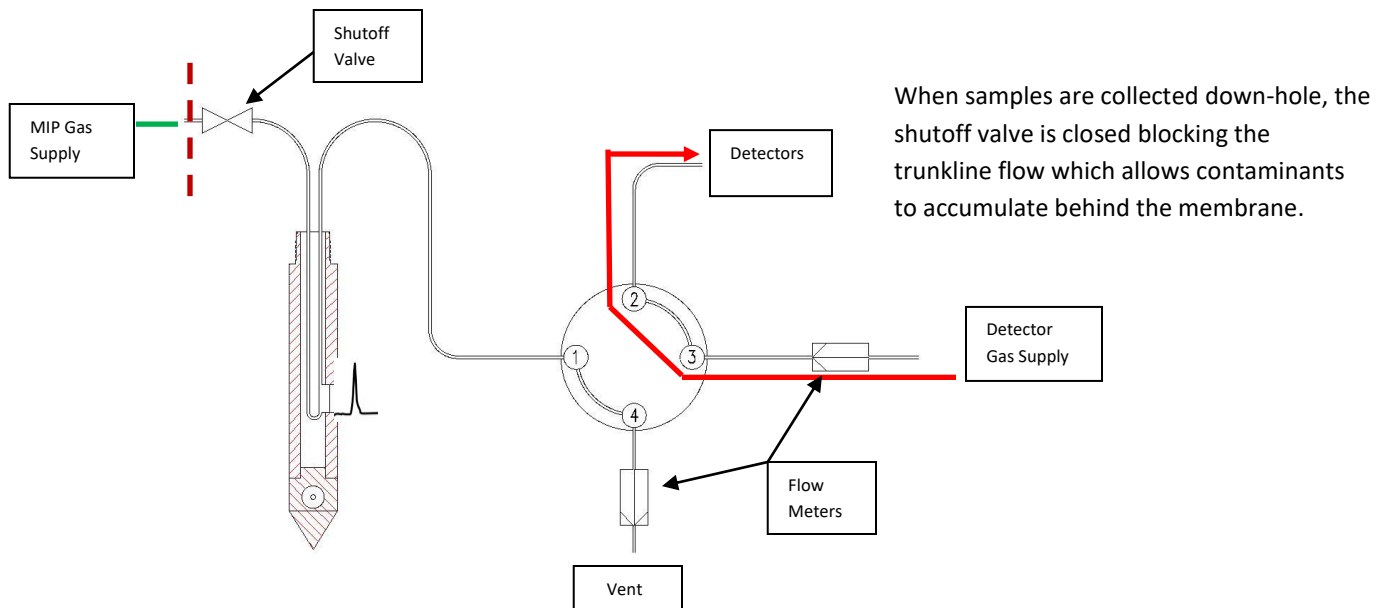

Figure 12: Configuration #1 is the primary valve configuration used in standby, collection and transport modes.

In Figure 13, the trunkline carrier gas is restarted and flowing through the 4-port valve positions 1-4 and venting through a flow meter. Clean carrier gas from GC is cycling through a flow meter then through valve positions 3-2 and onto the detectors.

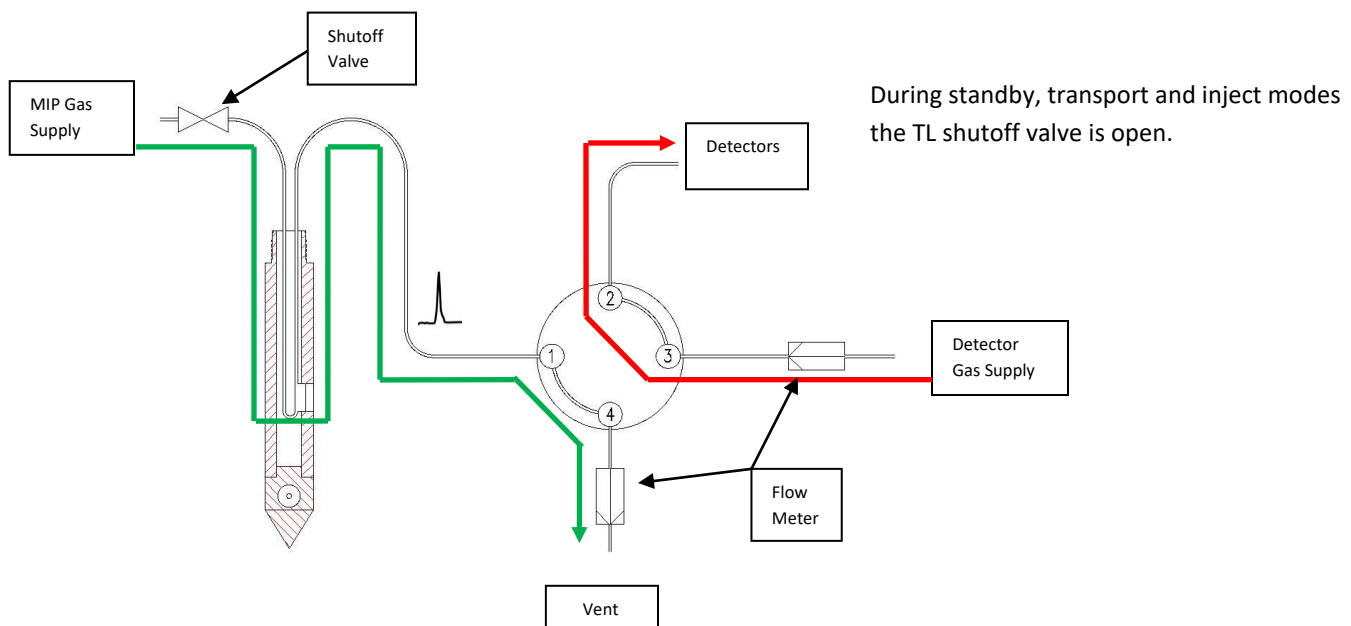

Figure 13: Transport of the sample to the surface with the valve still in the primary configuration.



In Figure 14, the 4-port valve is switched to direct the trunkline carrier gas to the detectors through valve ports 1-2. This is valve configuration 2 which is used only during the “inject to detector” mode which is at the end of the transport mode as the sample peak approaches the top of the trunkline.

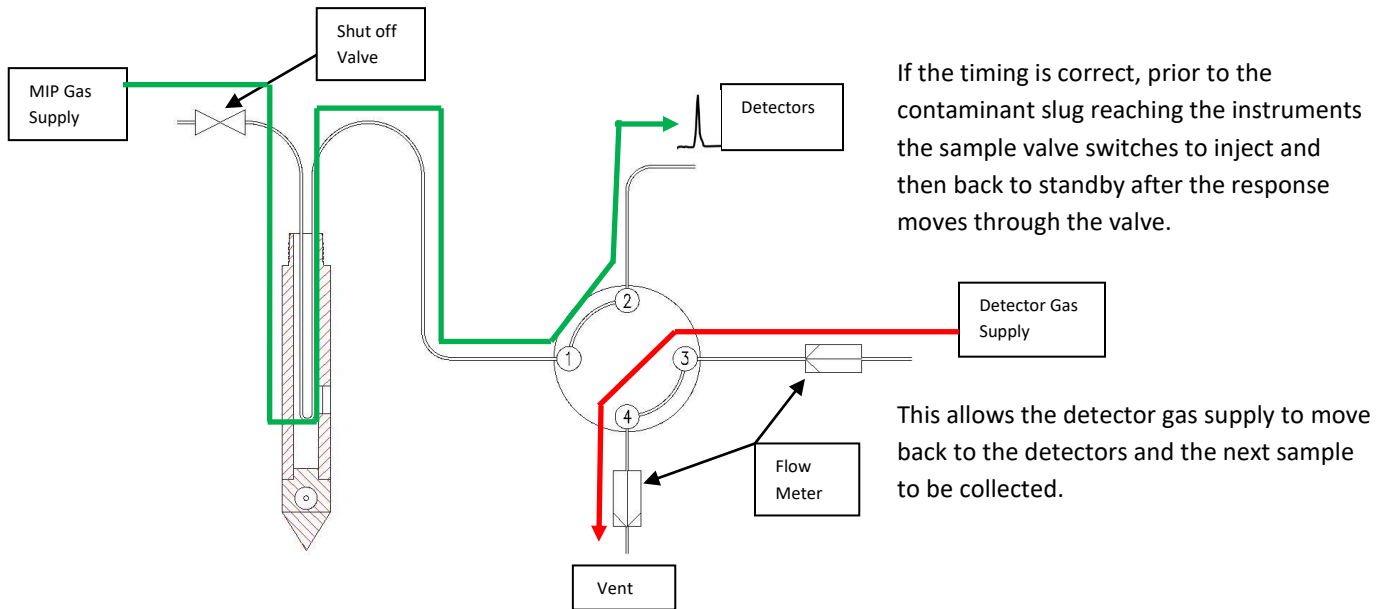

Figure 14: Redirection of the sample to the detectors occurs in valve configuration #2: This valve configuration is used only during the injection mode.

Figure 15 is the standby mode which occurs when the “inject to detector” time has expired. The valve switches directing the trunkline carrier gas through the 4-port valve positions 1-4 and venting through a flow meter. Clean carrier gas from GC is cycling through a flow meter then through valve positions 3-2 and onto the detectors.

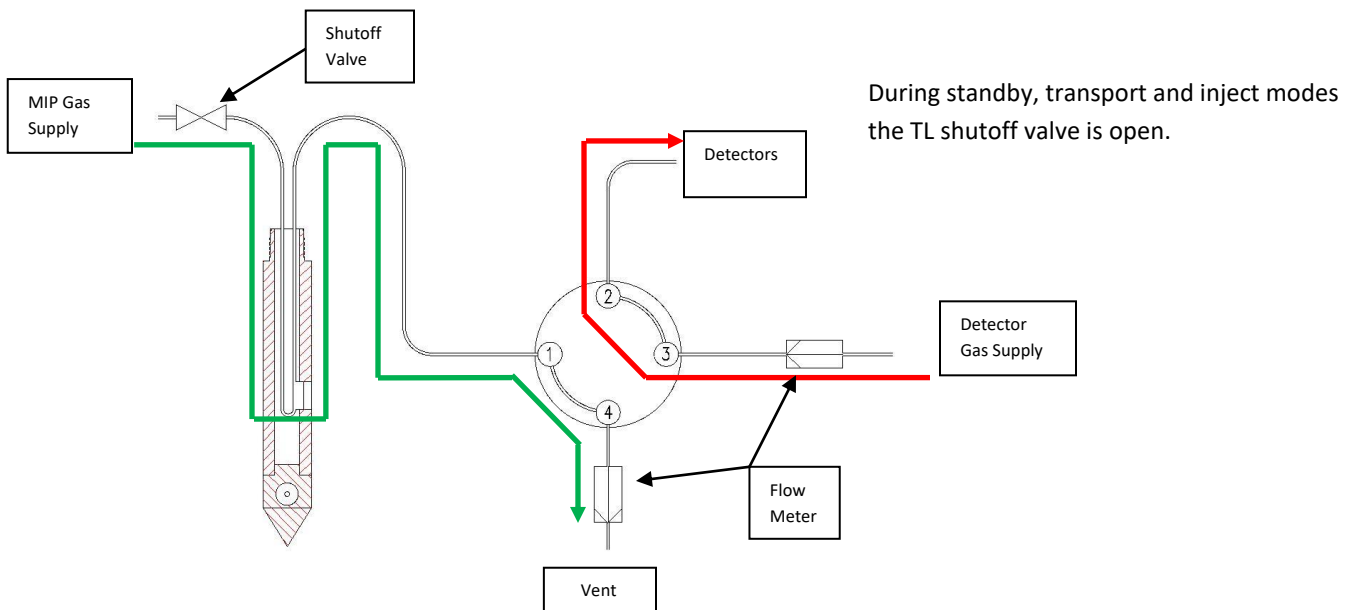

Figure 15: Standby mode with the valve in the primary configuration.