

# 4

## Geotechnical Sampling

[geoprobe.com/geotech-sampling](http://geoprobe.com/geotech-sampling)

Guided by feedback from the field and focused on making your job easier, we continually develop and test new and innovative products and techniques – from standard penetration testing, and beyond. If you're seeking a competitive advantage, integrating some direct push methods such as out-the-end sampling into long-standing geotechnical practices can save you significant time on jobs.

### What's New

- DT325 Driven Casing SPT (OTE)
- Geoprobe® manufactured AWJ drill rod
- 3126GT & 3145GT geotechnical drill rigs
- 7-in. breakout storage rack weldment



7-in. Breakout  
Storage Rack  
Weldment



**3145GT**  
Geotechnical Drill Rig



**3126GT**  
Geotechnical Drill Rig



Split Spoon Sample



## Interlocking Split Spoon Sampler

Fast and durable patented Interlocking Split Spoon Sampler saves time and money. New: 3-in. option available.

[geoprobe.com/split-spoon](http://geoprobe.com/split-spoon)

### ADAPTABLE

Variety of drive heads available (AWJ, AW, NWJ)

### 2X THE STRENGTH & DURABILITY

Enhanced material properties result in greater longevity

### STRONGER

The patented interlocking design strengthens the entire sheath

### ELIMINATES BULGING/BOWING

Sheath stays aligned during advancement

### ASTM STANDARD

Design meets ASTM Standard D1586 (2-in. size)

**PATENTED**

Split tube soil sampling system manufactured under U.S. Patent 9,551,188



## Spring Assisted Swivel Lift Cap

Designed to reduce operator fatigue when adding or removing sections of rods to the tool string.

[geoprobe.com/lift-cap](http://geoprobe.com/lift-cap)



- |                                 |                                |
|---------------------------------|--------------------------------|
| <b>2.25 (Box)</b><br>MN: 226053 | <b>4.5 (Box)</b><br>MN: 234931 |
| <b>2.25 (Pin)</b><br>MN: 217609 | <b>NWJ (Pin)</b><br>MN: 230334 |
| <b>3.25 (Box)</b><br>MN: 235367 | <b>AWJ (Pin)</b><br>MN: 231440 |
| <b>3.75 (Box)</b><br>MN: 234939 |                                |

[geoprobe.com/lift-cap](http://geoprobe.com/lift-cap)



See how the Spring Assisted Swivel Lift Cap helps operators in the field.

# DT325 Driven Casing SPT (OTE)

geoprobe.com/325ote



785-825-1842

SPT sampling can be conducted out-the-end of the DT325 sampling system.

### Key Features

- lightweight
- fast
- provides a continuous sample
- does not require drilling fluid
- no soil compaction



SOIL SAMPLING OPTION

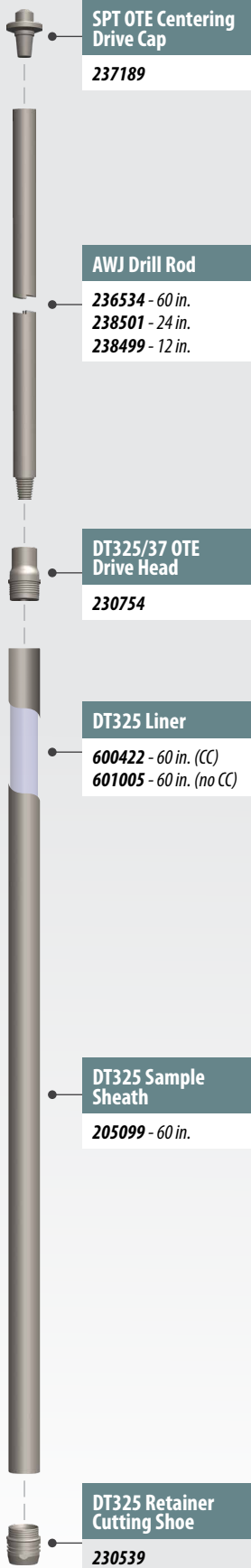

OUTER ROD STRING

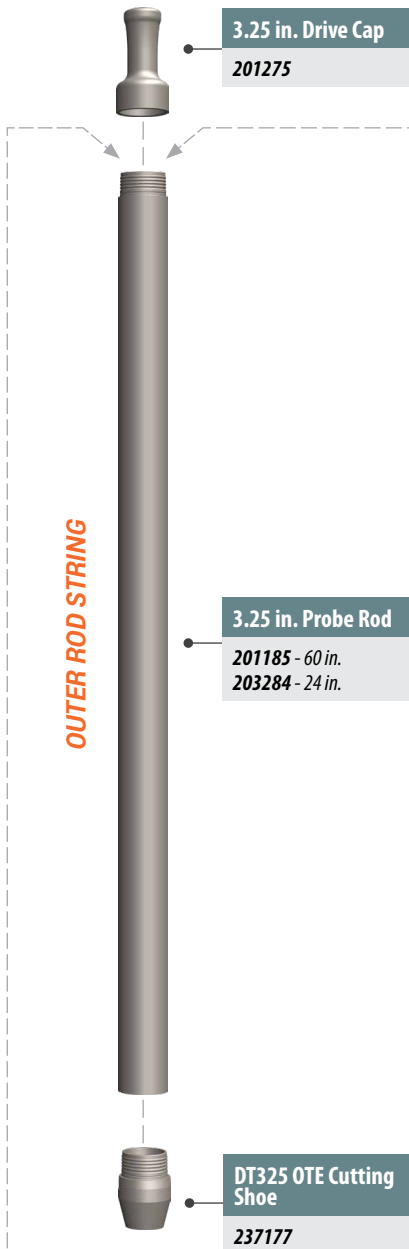

SPT SAMPLING

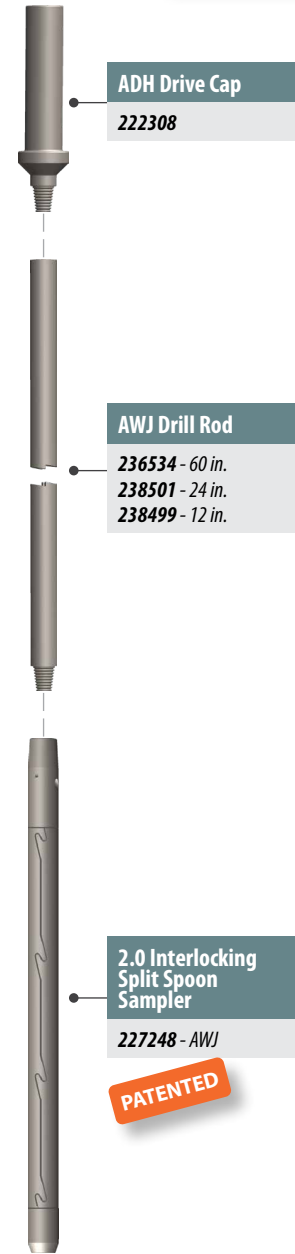

Split tube soil sampling system manufactured under U.S. Patent 9,551,188

geoprobe.com



## Outer Rod String







Components	Part	MN	Notes
	<b>3.25 in. Drive Cap</b>	201275	GH60, Threadless
	<b>DT325 OTE Cutting Shoe</b> <span style="color: red; font-weight: bold;">NEW</span>	237177	2.38 in. ID, 3.45 in. OD

3.25 in. Probe Rod	MN	Length	Weight	OD	ID
	201185	60 in.	49 lbs.	3.25 in.	2.625 in.
	203284	24 in.	19.6 lbs.		







## AWJ Drill Rods

Components	Part	MN	Notes
	<b>AWJ Drill Rod</b> <span style="color: red; font-weight: bold;">NEW</span>	236534	60 in.
		238501	24 in.
		238499	12 in.

## SPT Sampling

Components	Part	MN	Notes
	<b>ADH Drive Cap</b>	222308	AWJ, Pin Down, Threaded
	<b>2.0 Interlocking Split Spoon Sampler</b>	227248	AWJ
	<b>2.0 Interlocking Split Spoon Basket</b>	113340	
	<b>2.0 Interlocking Split Spoon Basket Bypass Ring</b> <span style="color: red; font-weight: bold;">NEW</span>	239568	
	<b>2.0 Interlocking Split Spoon Cutting Shoe</b>	225524	
	<b>2.0 Interlocking Split Spoon Cutting Shoe</b> <span style="color: red; font-weight: bold;">NEW</span>	236717	Blunt Nose (Does not meet ASTM standard)



## Soil Sampling Option

Components	Part	MN	Notes
	<b>SPT OTE Centering Drive Cap</b> <span style="color: red; font-weight: bold;">NEW</span>	237189	For use inside 3.25 in. Probe Rods
	<b>DT325/37 OTE Drive Head</b>	230754	AWJ Box
	<b>DT325 Sample Sheath</b>	205099	60 in.
	<b>DT325 Liner (Core Catcher)</b>	600422	60 in., PVC Quantity: 42
	<b>DT325 Liner (No Core Catcher)</b>	601005	60 in., PVC Quantity: 42
	<b>DT325 Liner Cutter</b>	205017	
	<b>DT325 Retainer Cutting Shoe</b>	230539	



## Discrete Sampling Option

Components	Part	MN	Notes
	<b>DT325/37 OTE Discrete Point</b>	231156	AWJ Box

## Accessories

Components	Part	MN	Notes
	<b>DT325 Liner Retainer Wrench</b>	205299	
	<b>Rod Wiper Donut</b>	600418	3.25 in. (Weldment: 204387)
	<b>Rod Wiper Weldment</b>	204387	

## Lifting / Pulling

Components	Part	MN	Notes
	<b>RG Handle Assembly</b>	201277	3.25 in., GH60
	<b>3.25 in. Spring Assisted Swivel Lift Cap</b> <span style="color: red; font-weight: bold;">NEW</span>	235367	Box
	<b>AWJ Spring Assisted Swivel Lift Cap</b>	231440	AWJ, Pin

## 3.25 Driven Casing

[geoprobe.com/ote](http://geoprobe.com/ote)



Watch how the  
DT325 Driven  
Casing SPT system  
can be used for  
geotech work.

# DT37 Driven Casing SPT (OTE)

geoprobe.com/37ote



785-825-1842



Customers describe out-the-end SPT sampling as more efficient than drive-and-wash in the right soil conditions, amplifying the amount they can accomplish in a day. Retrieving continuous samples in greater depths impresses engineers. This waterless SPT sampling can save you time and boost your profits.

SOIL SAMPLING OPTION

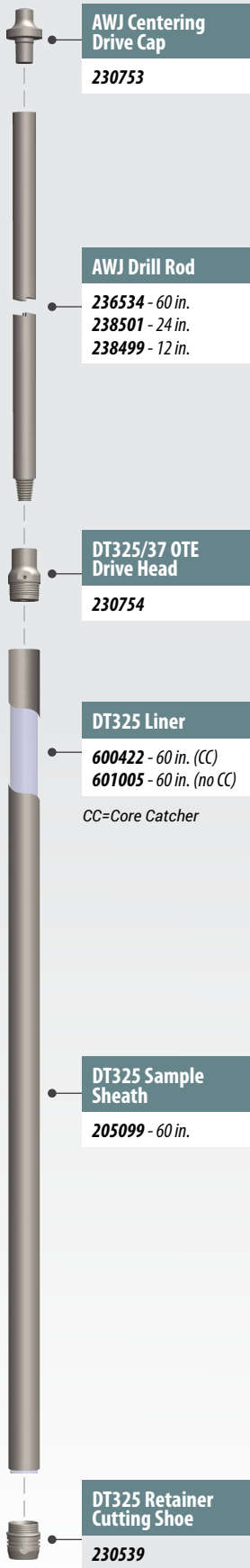

OUTER ROD STRING

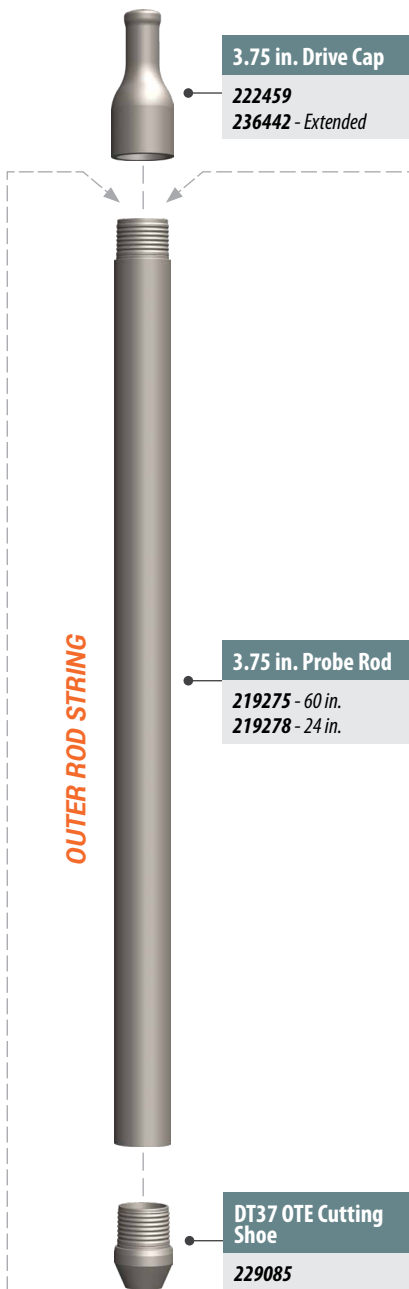

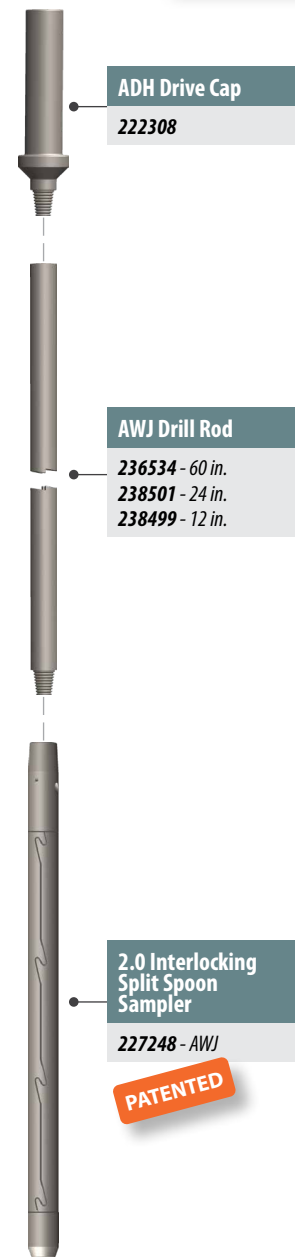

SPT SAMPLING



Split tube soil sampling system manufactured under U.S. Patent 9,551,188

Outer Rod String

Components	Part	MN	Notes
	3.75 in. Drive Cap	222459	GH60, Threadless
	3.75 in. Drive Cap	236442	GH60, 70, 80, Threadless, Extended
	DT37 OTE Cutting Shoe	229085	2.38 in. ID, 3.90 in. OD

3.75 in. Probe Rod	MN	Length	Weight	OD	ID
	219275	60 in.	67.5 lbs.	3.75 in.	3 in.
	219278	24 in.	27 lbs.		

AWJ Drill Rods

Components	Part	MN	Notes
	AWJ Drill Rod	236534	60 in.
		238501	24 in.
		238499	12 in.

SPT Sampling

Components	Part	MN	Notes
	ADH Drive Cap	222308	AWJ, Pin Down, Threaded
	2.0 Interlocking Split Spoon Sampler	227248	AWJ
	2.0 Interlocking Split Spoon Basket	113340	
	2.0 Interlocking Split Spoon Basket Bypass Ring	239568	
	2.0 Interlocking Split Spoon Cutting Shoe	225524	
	2.0 Interlocking Split Spoon Cutting Shoe	236717	Blunt Nose (Does not meet ASTM standard)

Soil Sampling Option

Components	Part	MN	Notes
	AWJ Centering Drive Cap	230753	For use inside 3.75 in. Probe Rods
	DT325/37 OTE Drive Head	230754	AWJ Box
	DT325 Sample Sheath	205099	60 in.
	DT325 Liner (Core Catcher)	600422	60 in., PVC Quantity: 42
	DT325 Liner (No Core Catcher)	601005	60 in., PVC Quantity: 42
	DT325 Liner Cutter	205017	
	DT325 Retainer Cutting Shoe	230539	

Discrete Sampling Option

Components	Part	MN	Notes
	DT325/37 OTE Discrete Point	231156	AWJ Box

Accessories

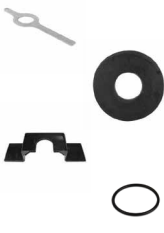
Components	Part	MN	Notes
	DT325 Liner Retainer Wrench	205299	
	Rod Wiper Donut	112826	3.75 in.
	Rod Wiper Weldment	204387	
	O-Ring	106093	

Lifting / Pulling

Components	Part	MN	Notes
	RG Handle Assembly	220413	3.75 in., GH60
	3.75 in. Spring Assisted Swivel Lift Cap	234939	Box
	AWJ Spring Assisted Swivel Lift Cap	231440	AWJ, Pin

31 Series Overview

[geoprobe.com/31series](http://geoprobe.com/31series)



See how the Geoprobe® 31 Series rigs make drilling faster, easier, and safer.

INNER PILOT BIT ASSEMBLY

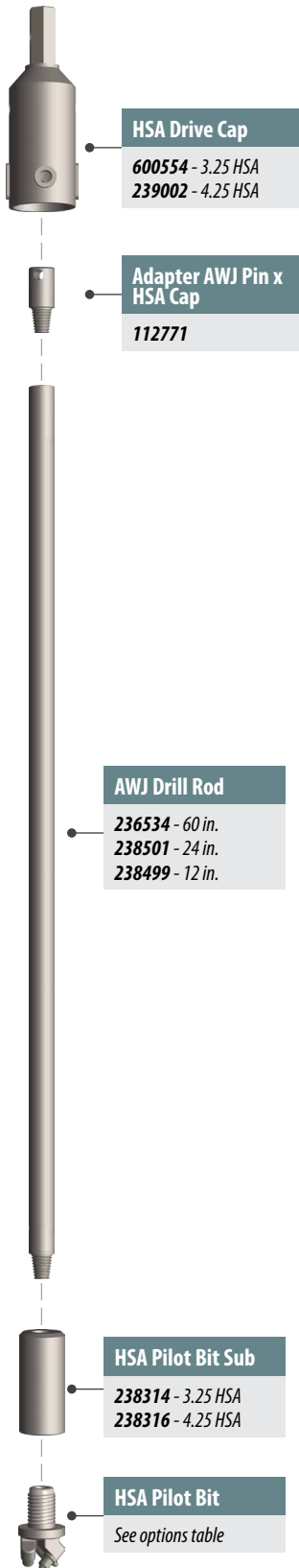

Drilling tools such as hollow stem augers are turned to the desired depth with a pilot bit blocking the off the auger ID. The pilot bit is pulled and a split barrel sampler (split spoon) is lowered. The drop hammer is then placed on top of the rod string and the number of blows to advance the sampler is counted. The pilot bit can then be placed back in the augers and the auger string advanced to the next testing depth.

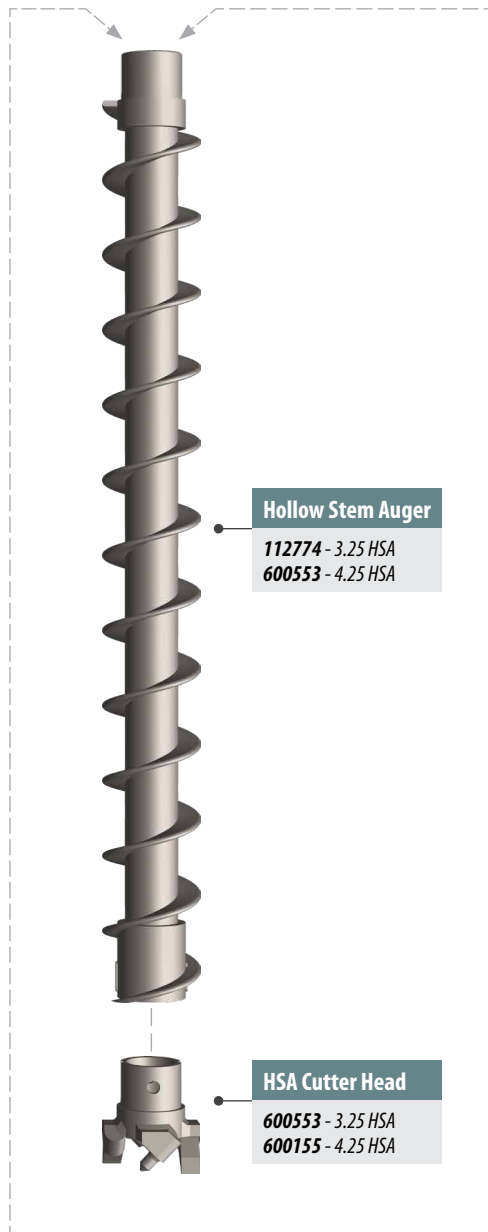

SPT SAMPLING



**PATENTED**

Split tube soil sampling system manufactured under U.S. Patent 9,551,188

**SPT SAMPLING (3.25 HSA)**

*Hollow Stem Augers*

Components	Part	MN	Notes
	<b>3.25 in. Hollow Stem Auger</b>	112774	60 in.
	<b>3.25 in. HSA Cutter Head</b>	600553	7.5 in. OD, Spade / Bullet

*Inner Pilot Bit Assembly*

Components	Part	MN	Notes
	<b>3.25 in. HSA Drive Cap</b>	600554	1-5/8 Hex Drive
	<b>Adapter AWJ Pin x HSA Cap</b>	112771	
	<b>3.25 HSA Pilot Bit Sub N4 x AWJ</b> <b>NEW</b>	238314	7.00 in. S-S
	<b>3.25 in. HSA Pilot Bit</b>	113083	Bullet N4 Pin
	<b>3.25 in. HSA Pilot Bit</b>	600635	Drag N4 Pin
	<b>HHCS 3/4-10NC x 5.5 GR5 ZN</b>	102003	
	<b>Nut Hex</b>	101227	3/4-10NC GR5 ZN

*Auger Accessories*

Components	Part	MN	Notes
	<b>3.25 in. Auger Puller</b>	226279	Legacy GH60, 6712DT, 7822DT, 6011DT
	<b>3.25 in. Auger Fork</b>	600636	
	<b>3.25 in. HSA Plastic Plug</b>	600740	
	<b>3.25 in. HSA Hoisting Cap</b> <b>NEW</b>	235914	

**SPT SAMPLING (4.25 HSA)**

*Hollow Stem Augers*

Components	Part	MN	Notes
	<b>4.25 in. Hollow Stem Auger</b>	600154	60 in.
	<b>4.25 in. HSA Cutter Head</b>	600155	8.75 in. OD Spade / Bullet

*Inner Pilot Bit Assembly*

Components	Part	MN	Notes
	<b>4.25 in. HSA Drive Cap</b>	239002	1-5/8 Hex Drive
	<b>Adapter AWJ Pin x HSA Cap</b>	112771	
	<b>4.25 HSA Pilot Bit Sub 2-3/8 REG x AWJ</b> <b>NEW</b>	238316	7.00 in. S-S
	<b>4.25 in. HSA Pilot Bit</b> <b>NEW</b>	600672	Bullet 3.38 Reg Pin
	<b>4.25 in. HSA Pilot Bit</b>	600156	Apex 3.38 Reg Pin
	<b>HHCS 3/4-10NC x 6.5 GR5 BLK</b>	100194	
	<b>Nut Hex</b>	101227	3/4-10NC GR5 ZN

*Auger Accessories*

Components	Part	MN	Notes
	<b>4.25 in. HSA Side Grip Puller</b>	202187	Legacy GH60, 6712DT, 7822DT, 6011DT
	<b>4.25 in. Auger Fork</b>	202081	
	<b>4.25 in. HSA Wooden Plug</b>	202104	
	<b>4.25 in. HSA Hoisting Cap</b> <b>NEW</b>	235915	

**COMBINED COMPONENTS**

*AWJ Drill Rods*

Components	Part	MN	Notes
	<b>AWJ Drill Rod</b> <b>NEW</b>	236534	60 in.
		238501	24 in.
		238499	12 in.

*SPT Sampling*

Components	Part	MN	Notes
	<b>ADH Drive Cap</b>	222308	AWJ, Pin Down, Threaded
	<b>2.0 Interlocking Split Spoon Sampler</b>	227248	AWJ
	<b>2.0 Interlocking Split Spoon Basket</b>	113340	
	<b>2.0 Interlocking Split Spoon Basket Bypass Ring</b> <b>NEW</b>	239568	
	<b>2.0 Interlocking Split Spoon Cutting Shoe</b>	225524	
	<b>2.0 Interlocking Split Spoon Cutting Shoe</b> <b>NEW</b>	236717	Blunt Nose (Does not meet ASTM standard)

*Combined Accessories*

Components	Part	MN	Notes
	<b>Drive Pin</b>	600616	.625 Diameter, 2.875 Tube
	<b>HSA Replacement Lock Bolt</b>	600157	
	<b>AWJ Spring Assisted Swivel Lift Cap</b>	231440	AWJ, Pin

S-S (Shoulder to Shoulder)

**SPT through 3.25 HSA**  
[geoprobe.com/325-hsa](http://geoprobe.com/325-hsa)



*This timelapse shows how quickly the Geoprobe® 3100GT takes SPT samples through 3.25 HSA.*



Solid augers are advantageous for creating open bore holes in stable, non-collapsing soil.

## Key Features

- does not require circulation fluids for easier site cleanup
- creates a nice, open bore hole in stable soils
- facilitates other sampling tasks such as split spoon sampling

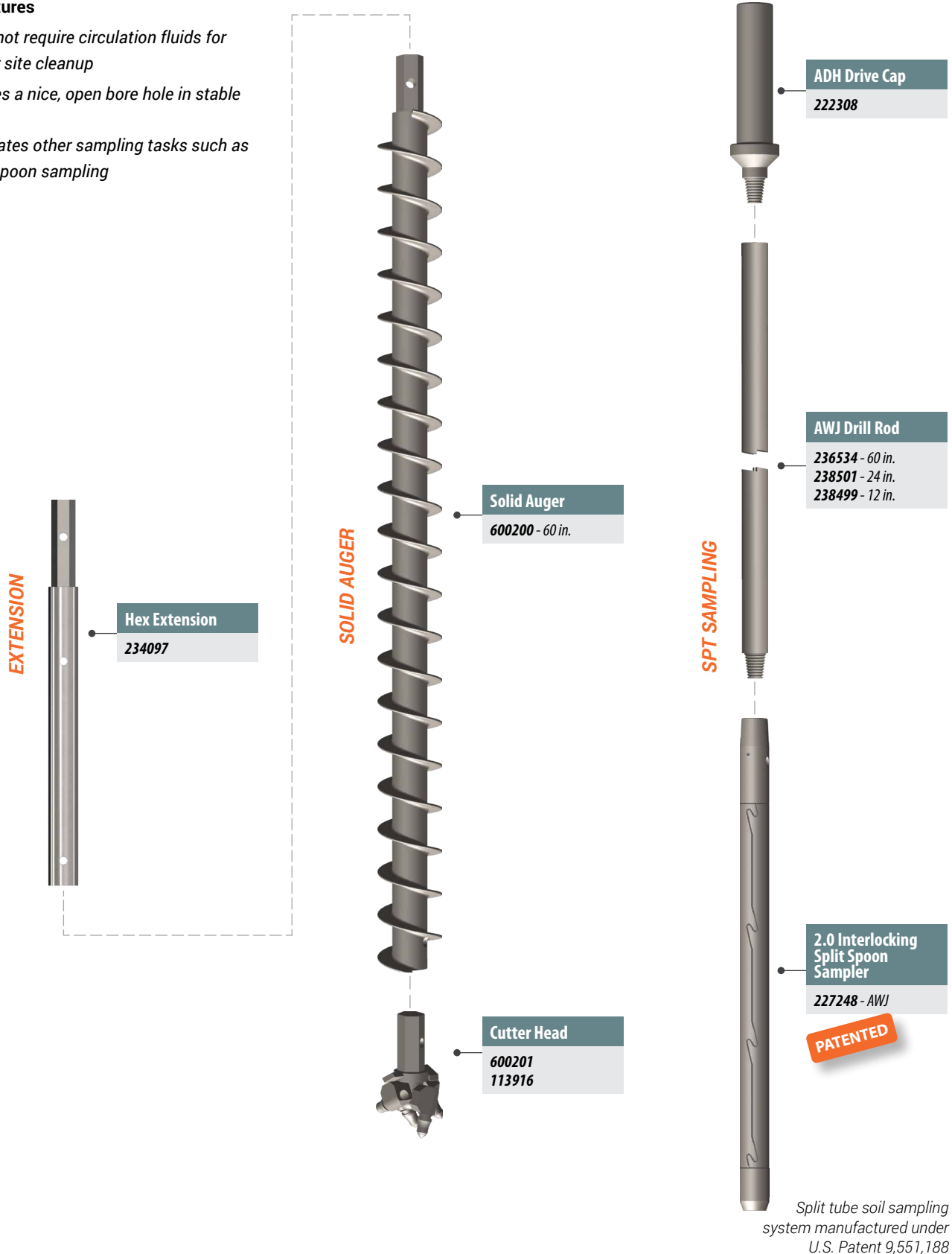

Solid Augers & Cutters

Components	Part	MN	Notes
	Solid Auger	600200	4.5 in. OD x 60 in. x 1.625 in. Hex
	Solid Auger Cutter Head	600201	4.5 in. OD x 1.625 in. Hex Bullet
	Cutter Head 5T	113916	4.5 in. OD, 1.625 in. Hex

AWJ Drill Rods

Components	Part	MN	Notes
	AWJ Drill Rod	236534	60 in.
		238501	24 in.
		238499	12 in.

SPT Sampling

Components	Part	MN	Notes
	ADH Drive Cap	222308	AWJ, Pin Down, Threaded
	2.0 Interlocking Split Spoon Sampler	227248	AWJ
	2.0 Interlocking Split Spoon Basket	113340	
	2.0 Interlocking Split Spoon Basket Bypass Ring	239568	
	2.0 Interlocking Split Spoon Cutting Shoe	225524	
	2.0 Interlocking Split Spoon Cutting Shoe	236717	Blunt Nose (Does not meet ASTM standard)

Accessories

Components	Part	MN	Notes
	Adjustable Center Rod Clamp	205182	1.25 in. Center Rod
	Drive Pin	600616	.625 Diameter, 2.875 Tube
	Drive Pin	113917	2.375 in. Tube
	Hex Extension	234097	12 in.
	2.25 in. HSA Auger Fork	203798	

Lifting / Pulling

Components	Part	MN	Notes
	Hex Lift Cap	230140	1.63 in. Hex
	AWJ Spring Assisted Swivel Lift Cap	231440	AWJ, Pin

Split tube soil sampling system manufactured under U.S. Patent 9,551,188

behind the **design**

**VIDEO**

[geoprobe.com/why](http://geoprobe.com/why)

**Interlocking Split Spoon Sampler**  
[geoprobe.com/split-spoon](http://geoprobe.com/split-spoon)



**FASTER IN THE FIELD**  
 The interlocking design self-aligns during assembly



**OPERATOR-FRIENDLY**  
 Multi-lead threads = fewer turns to put together and take apart

# SPT Sampling (3.75 & 4.5 Mud Rotary)

[geoprobe.com/mud-rotary](http://geoprobe.com/mud-rotary)

Effective in sand, silts, clay, gravel, cobbles, and boulders, mud rotary sampling is also used when coring bedrock since it is not hindered by the presence of groundwater.

Geotechnical Sampling

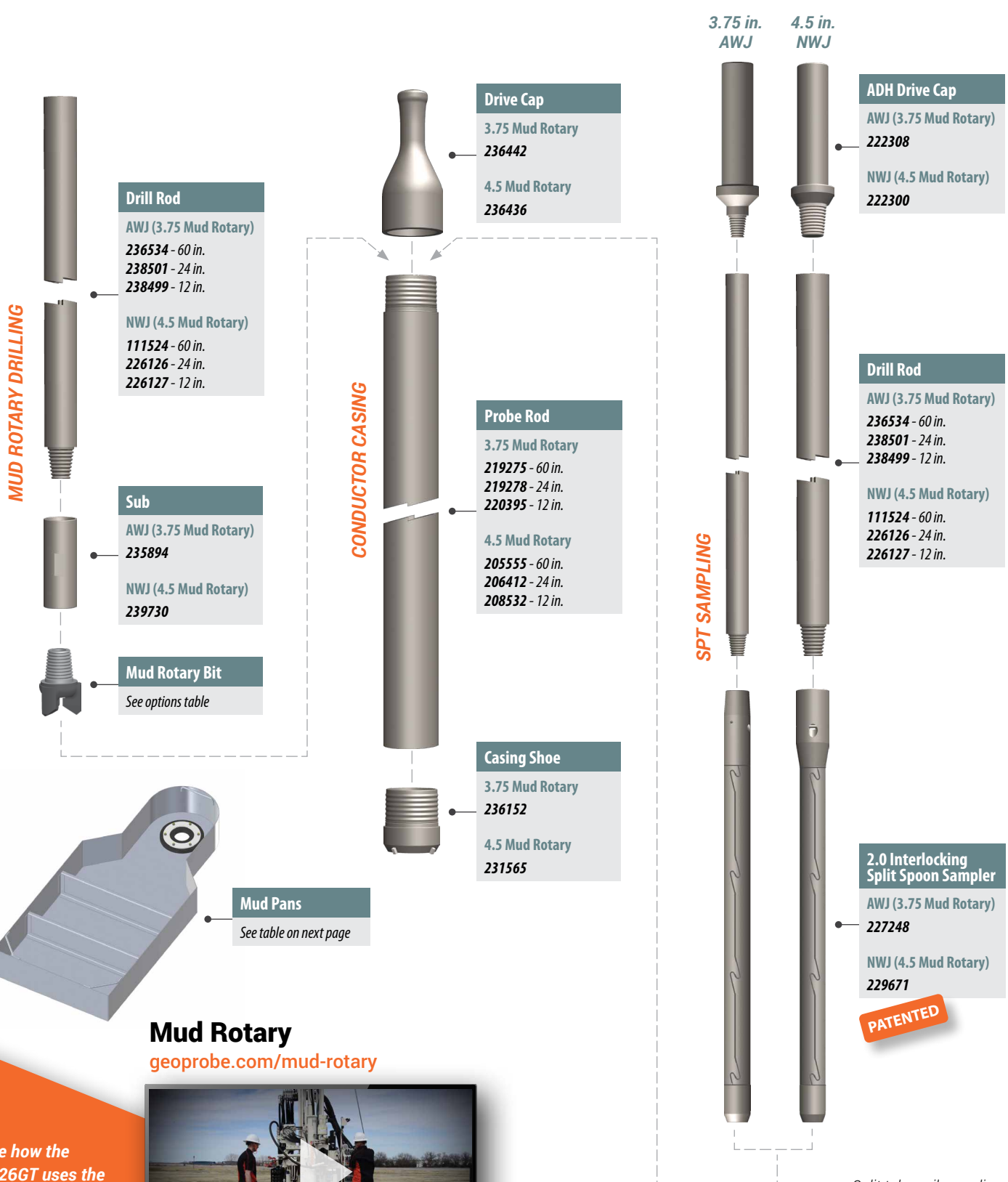

## Mud Rotary

[geoprobe.com/mud-rotary](http://geoprobe.com/mud-rotary)

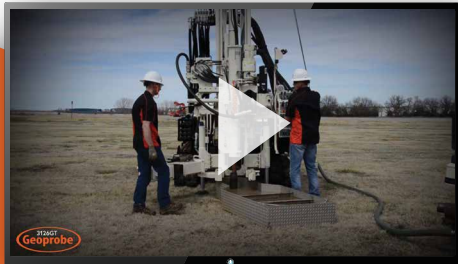

See how the 3126GT uses the head side-shift to make mud rotary easy in the field.



Split tube soil sampling system manufactured under U.S. Patent 9,551,188

**PATENTED**





VIDEO

**SPT SAMPLING (3.75 MUD ROTARY) AWJ**

*Conductor Casing*

Components	Part	MN	Notes		
	<b>3.75 in. Drive Cap</b> <i>NEW</i>	236442	GH60, 70, 80, Threadless, Extended		
	<b>3.75 in. Casing Shoe</b> <i>NEW</i>	236152	3.0 in. ID		
3.75 in. Probe Rod	MN	Length	Weight	OD	ID
	219275	60 in.	67.5 lbs.	3.75 in.	3 in.
	219278	24 in.	27 lbs.		
	220395	12 in.	13.5 lbs.		





*Mud Rotary Drilling*

Components	Part	MN	Notes
	<b>AWJ Drill Rod</b> <i>NEW</i>	236534	60 in.
		238501	24 in.
		238499	12 in.
	<b>N4 Box x AWJ Box</b> <i>NEW</i>	235894	6.00 in. S-S
	<b>Mud Rotary Bit (Side Discharge)</b> <i>NEW</i>	118032	Drag 2.88 in. OD N4 Pin
	<b>Mud Rotary Bit</b> <i>NEW</i>	117470	Drag 2.88 in. OD N4 Pin
	<b>Mud Rotary Bit</b> <i>NEW</i>	117472	Roller 2.88 in. OD N4 Pin

*SPT Sampling*



Components	Part	MN	Notes
	<b>ADH Drive Cap</b>	222308	AWJ, Pin Down, Threaded
	<b>2.0 Interlocking Split Spoon Sampler</b>	227248	AWJ

*Accessories*





Components	Part	MN	Notes
	<b>Rod Wiper Donut</b>	112826	3.75 in.
	<b>Rod Wiper Weldment</b>	204387	
	<b>3.75 in. Spring Assisted Swivel Lift Cap</b> <i>NEW</i>	234939	Box
	<b>AWJ Spring Assisted Swivel Lift Cap</b>	231440	AWJ, Pin
	<b>RG Handle Assembly</b>	220413	3.75 in., GH60

**SPT SAMPLING (4.5 MUD ROTARY) NWJ**

*Conductor Casing*

Components	Part	MN	Notes		
	<b>4.5 in. Drive Cap</b> <i>NEW</i>	236436	GH60, Threadless, Extended		
	<b>4.5 in. Casing Shoe</b>	231565	3.75 in. ID		
4.5 in. Probe Rod	MN	Length	Weight	OD	ID
	205555	60 in.	82.5 lbs.	4.5 in.	3.75 in.
	206412	24 in.	33 lbs.		
	208532	12 in.	16.5 lbs.		





*Mud Rotary Drilling*

Components	Part	MN	Notes
	<b>NWJ Drill Rod</b>	111524	60 in.
		226126	24 in.
		226127	12 in.
	<b>2-3/8 REG Box x NWJ Box</b> <i>NEW</i>	239730	8.00 in. S-S
	<b>Mud Rotary Bit (Side Discharge)</b> <i>NEW</i>	118033	Drag 3.63 in. OD 2.375 in. Reg
	<b>Mud Rotary Bit</b> <i>NEW</i>	117469	Drag 3.63 in. OD 2.375 in. Reg Pin
	<b>Mud Rotary Bit</b> <i>NEW</i>	117471	Roller 3.63 in. OD 2.375 Reg Pin





*SPT Sampling*



Components	Part	MN	Notes
	<b>ADH Drive Cap</b>	222300	NWJ, Pin Down, Threaded
	<b>2.0 Interlocking Split Spoon Sampler</b>	229671	NWJ

*Accessories*

Components	Part	MN	Notes
	<b>Rod Wiper Donut</b>	600448	4.5 in. (Weldment: 204387)
	<b>RG Handle Assembly</b>	206433	4.5 in., GH60 Series
	<b>4.5 in. Spring Assisted Swivel Lift Cap</b> <i>NEW</i>	234931	Box
	<b>NWJ Spring Assisted Swivel Lift Cap</b>	230334	NWJ, Pin

**COMBINED COMPONENTS**

Components	Part	MN	Notes
	<b>2.0 Interlocking Split Spoon Basket</b>	113340	
	<b>2.0 Interlocking Split Spoon Basket Bypass Ring</b> <i>NEW</i>	239568	
	<b>2.0 Interlocking Split Spoon Cutting Shoe</b>	225524	
	<b>2.0 Interlocking Split Spoon Cutting Shoe</b> <i>NEW</i>	236717	Blunt Nose (Does not meet ASTM standard)

Components	Part	MN	Notes
	<b>Thread Compound</b>	600729	1 Gallon
	<b>Mud Pan</b> <i>NEW</i>	234972	100 gallons, aluminum
	<b>Mud Pan</b>	217038	100 gallons, aluminum

S-S (Shoulder to Shoulder)